

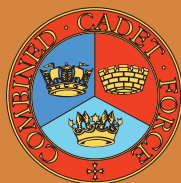

**air
cadets**
the next generation

air cadet publication
ACP 35

communications
volume 3 - advanced radio & radar



Amendment List		Amended by	Date Incorporated
No	Date		
1			
2			
3			
4			
5			
6			
7			
8			
9			
10			
11			
12			
13			
14			
15			
16			

ACP 35

COMMUNICATIONS

CONTENTS

Volume 1Radio Communications (Now ACP 31 Section 6)

Volume 2Communications Manual (Now ACP 44)

Volume 3.....Advanced Radio and Radar

Volume 4Satellite Communications

Volume 3

Advanced Radio and Radar

Chapter 1.....Communicating

Chapter 2.....Receivers

Chapter 3.....Radar

Chapter 4.....Equipments

Chapter 5.....Instructors Guide

CHAPTER 1

COMMUNICATING

Exchange of Information

Exchange of Information

1. Communication may be defined as the "exchange of information" and as such is a two-way process. Speech is one of the simplest methods of communication there is – and as you know, to use it effectively you need your voice to "transmit" a message (in the form of sound energy) and your ears to receive the reply. Notice that for 2-way communications, each person needs both a method of transmitting information and a method of receiving it.

2. However, using sound does have some drawbacks:

Speed of Sound

a. Speed of travel is quite slow at 300 m/s (the speed of sound).

Air as a medium

b. Sound will not travel through a vacuum – it needs a "medium" (normally air) to transmit the energy.

c. Sound does not travel very far, even if you have a loud voice.

d. The sound can be distorted by outside factors such as echoes, wind and other unwanted noises.

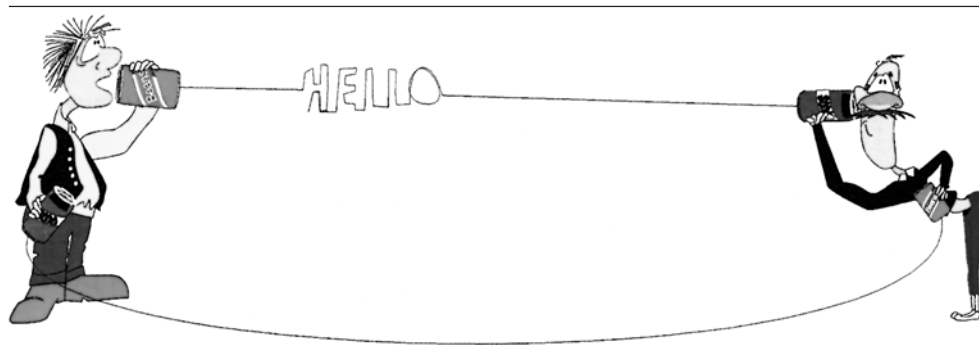

Fig 1-1: Communicating through string

3. You can improve the way sound travels by replacing air with a solid material. The string in the example carries the sound much better than air – you can speak quietly into one can, and the person holding the other one against an ear can hear you easily. And we all know the old Red Indian trick of putting one ear to the ground to detect the sounds of distant horsemen!

Radio – uses a different energy

4. While sound works well over short distances, for long-range communications an alternative method must be used – radio. A radio communications system consists

of a transmitter (Tx), to send the message and a receiver (Rx) to receive the reply. The link between the Tx and Rx is this time not sound energy, but electromagnetic (em) energy, - radio waves. Just like light from the sun, radio waves can travel not only through air, but also through a vacuum – and they travel at the same extremely high speed.

Electromagnetic – ‘em’ energy

Fig 1-2: From transmitter to receiver

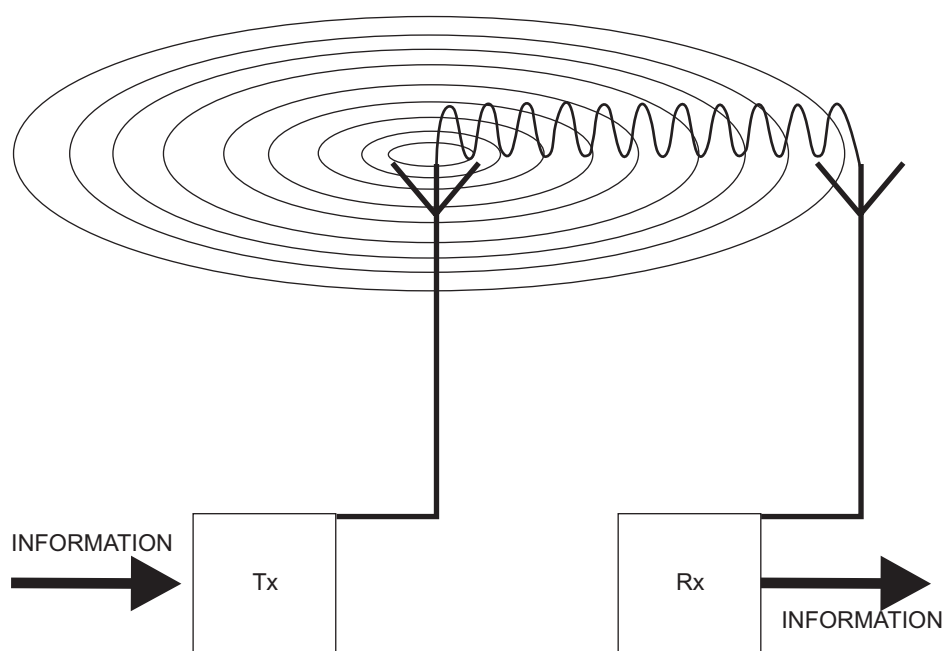

5. The job of the transmitter is to convert information into ‘em’ radiation. The information may be sound, TV pictures or digital codes similar to those used by computers. The ‘em’ radiation from the transmitter will then travel in all directions from the aerial. The receiver picks up this signal and converts the ‘em’ radiation back into information.

6. Transmitters come in all shapes and sizes. Your television remote control is one, and so is that for the car alarm. Such devices will have a very small power output of about 50 milliwatts. A television or a radio transmitter will, on the other hand, have a power rating of up to 500 kilowatts. These very high-powered equipments are needed to make transmissions reach to all parts of the country.

What is 'em'?What is electromagnetic energy?

7. When an alternating electric current flows in a wire, both magnetic and electric fields are produced outside the wire. It is the combination of these two fields that form 'em' waves. Some can be used for radio communications – radio waves. The frequency of the alternating current will determine the frequency of the 'em' waves produced, and its power rating will govern the range of radiation. There is no theoretical limit to the frequency of 'em' waves, and the expression "electromagnetic spectrum" has been coined to embrace all radiations of this type, which include heat and light.

Frequency and Wavelength

8. Electromagnetic radiation travels in waves in a similar fashion to sound waves travelling through air. The waves travel in all directions from their source rather like the pattern produced when a stone is dropped into the water in a still pond.

A typical wave is usually represented like this:

Fig 1-3: A typical waveform

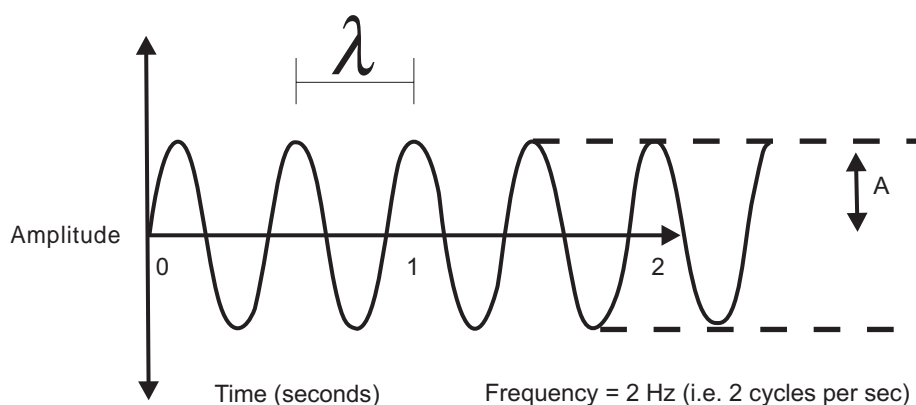

SOME DEFINITIONS

Relationship between frequency, wavelength and velocity

Frequency (**f**) the number of complete vibrations or fluctuations each second (i.e. cycles per sec).

Amplitude (**a**) the distance between 0 on the Amplitude axis and a crest.

Wavelength (**λ**) the distance between any two identical points in a wave (literally the length of one wave).

Velocity (**v**) the speed with which the waves moves is given by the formula: $v = f \lambda$

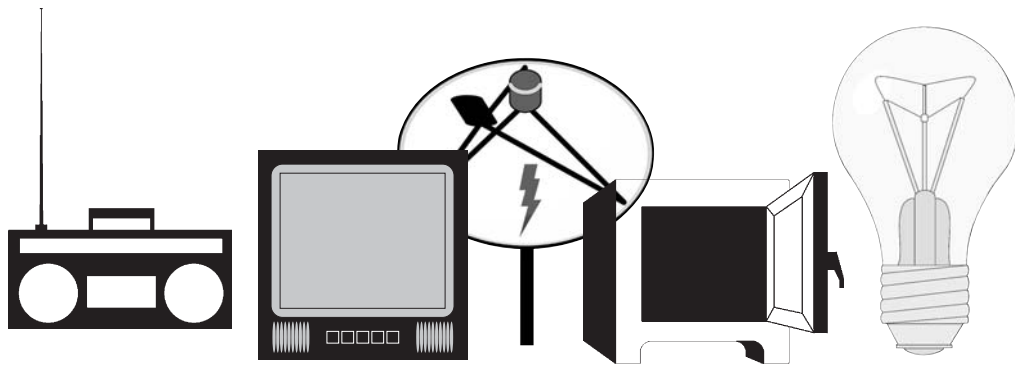

Fig 1-3: Comparative Wavelengths in common usage

Advantages of 'em'

Why use electromagnetic energy

9. Using 'em' energy to carry our communications information has many advantages compared with sound energy:
 - a. Speed of travel is extremely fast, at the speed of light, it is always 3×10^8 metres/second (sometimes expressed as "ms⁻¹"), which is 186,000 miles/second.
 - b. 'Em' waves will travel through a vacuum and so can be used for communication in space.
 - c. 'Em' waves travel a long way for a given power rating.

Wavelength affects efficient aerial lengthWhy use such high frequencies?

10. Aerials used for transmission or reception operate best at certain wavelengths. The length of the aerial dictates the frequency at which it will transmit and receive most readily, and aerial lengths of $\lambda/2$ for horizontal polarisation and $\lambda/4$ for vertical polarisation are particularly efficient. As we know the velocity of the waves and, if given the frequency, we can calculate the wavelength and the best aerial lengths for that frequency. The wavelength is calculated by dividing the velocity of the wave by its frequency.

$$\lambda = \frac{v}{f}$$

When f is the frequency, v is the velocity (3×10^8 metres/second) and λ is the wavelength.

Example:

What horizontally polarised aerial length would suit a frequency of 200KHz?

$$\lambda = \frac{3 \times 10^8}{200 \times 10^3}$$

$$\lambda = 1.5 \times 10^3$$

$$\lambda = 1500 \text{ metres}$$

Therefore an aerial length of 750 metres is required for best results.

Notice – the higher the frequency, the shorter the aerial required. What does this tell us about the operating frequency of a car-mounted CB compared to a hand held mobile phone?

Radio**Marconi's first message in 1901**

11. In 1901 the Italian engineer and physicist Guglielmo Marconi was the first man to transmit and receive transatlantic radio signals. The radio waves were sent in groups of short and long signals by switching the transmitter "OFF" and "ON" – Morse code. Although effective, this system did depend on the operators learning Morse code – not something everybody could do. For a system that everyone could use, some way of making the radio waves to carry more information had to be found.

12. 'Em' energy can be made to carry speech if we combine the low-frequency currents produced by speaking into a microphone, with the high-frequency currents that produce radio waves. This combination process is called modulation.

Modulation

Combining high and low frequencies – modulation

13. For the transmission of sounds such as speech and music, the sound waves are converted by a microphone into an oscillating electric current which varies at the same frequency as the sound wave. This is called an "audio-frequency" current.

Oscillator provides RF

14. An electronic circuit called an oscillator produces a continuous highfrequency (radio frequency) current which has a fixed frequency chosen from the range 100 KHz to 1 GHz. This fixed-frequency alternating current produces the 'em' "carrier" wave. The audio-frequency (AF) current and the radio-frequency (RF) current are mixed in the transmitter so that the carrier wave is MODULATED by the AF current, in such a way as to duplicate the pattern of sound waves fed into the microphone. A carrier wave can be modulated in one of two ways, either by amplitude modulation (AM) or by frequency modulation (FM).

Amplitude Modulation (AM)

AM

15. The simplest form of amplitude modulation (AM) is basically the way Marconi sent his first transatlantic message. The transmitter is switched alternately "ON" and "OFF" to interrupt the carrier wave. This modulates the amplitude from maximum to zero, and then back to maximum, producing pulses which represent the dots and dashes of the Morse Code.

Fig 1-5: Amplitude Modulated carrier wave

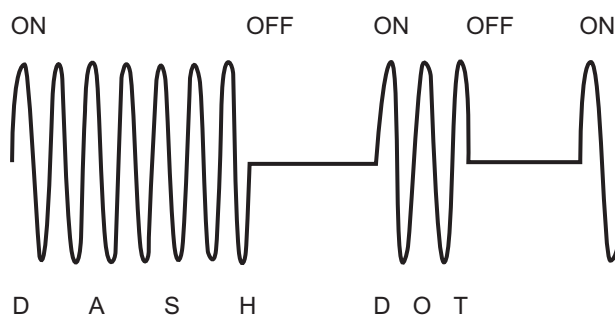

16. Whilst this system is ideal for Morse, it is not good enough for speech or music, because sound requires many more variations (or steps) to achieve an accurate reproduction. An improvement is to alter the amplitude of the high-frequency tone (the carrier wave) in step with the lower frequency audio tone.

Fig 1-6: Carrier wave plus AM wave form

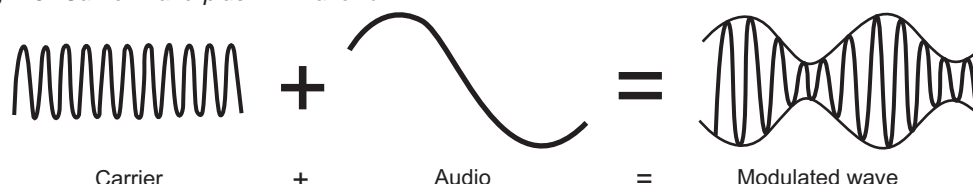

Basic AM Transmitter

17. The diagram (Fig 1-7) shows the various stages of a simple AM transmitter

Fig 1-7: AM transmitter block diagram

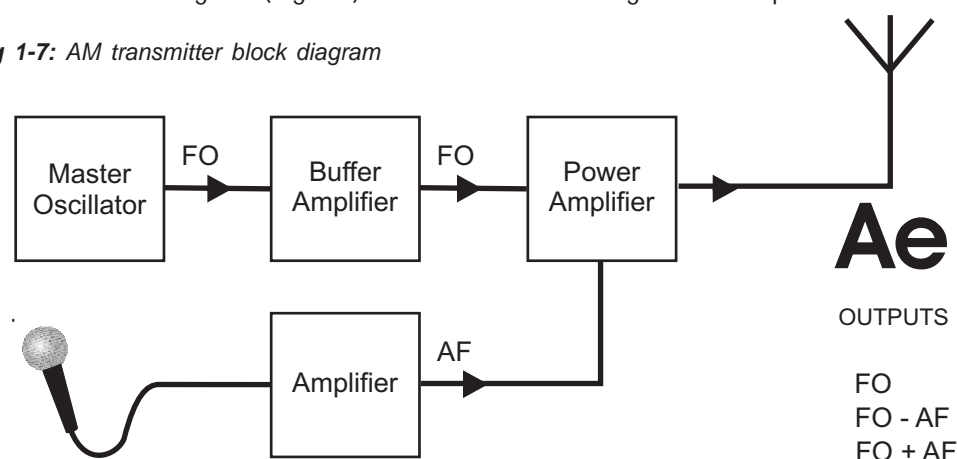

Parts of the basic transmitter

- | | |
|----------------------|--|
| a Master Oscillator. | <i>This generates a sinusoidal voltage (the carrier) at the required RF frequency (FO). Oscillators are often crystal-controlled to ensure good frequency stability.</i> |
| b Buffer Amplifier. | <i>This isolates the oscillator from the power amplifying stage, and prevents instability occurring.</i> |
| c Power Amplifier. | <i>This is used to increase the power of the signal to the required level before radiation from the aerial (AF).</i> |
| d Amplifier. | <i>This amplifies the microphone signal to the desired level for output.</i> |

18. The modulation takes place in the power amplifier stage. If the input frequencies to the modulator are FO from the oscillator and AF from the microphone, we find that the output of the power amplifier will consist of 3 frequencies:

- a. The carrier (FO).
- b. The carrier minus the tone frequency (speech) (FO - AF).
- c. The carrier plus the tone frequency (FO + AF).

19. For example, if the audio frequency ranged from 300 to 3000 Hz and the carrier was 1 MHz, then the frequencies in the output would look like:

Fig 1-8: Carrier and sidebands

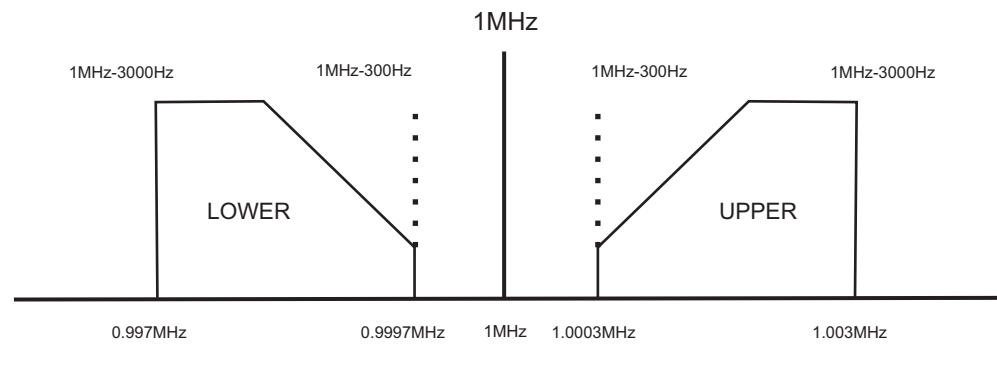

20. In the diagram you can see two sidebands to the carrier frequency, an upper sideband and a lower sideband. Some modes of operation use only one, and this is called single sideband (SSB) transmission. Transmitting only one sideband reduces the size and weight of the transmitter – important factors when talking about aircraft systems. The great drawback with the AM system is the need for such a large bandwidth (i.e. all frequencies including both sidebands, approximately 6KHz) in a limited frequency spread (30 KHz to 3 MHz i.e. Medium band). This means in reality that the AM system could only have 148 stations at any one time. Try tuning through an AM band radio and see how close the stations are together! Obviously, when many transmitters are crammed into a small band and overlap each other there is a big problem with signals from other transmissions breaking into the one you are using – this is known as "interference". To overcome this, the use of short-range frequency modulated systems has become popular.

FM – high quality broadcastsFrequency Modulation (FM)

21. With frequency modulation, the carrier wave has a constant amplitude and a much higher frequency than AM signals. Modulation is achieved by shifting the carrier frequency up and down slightly in step with the tone frequency. Although this shift is small it gives better results because it is less prone to atmospheric or manmade noise. Try listening to an AM signal as you pass by an electric pylon or enter a tunnel. The AM signal is distorted or lost, but an FM signal will be largely unaffected by the same conditions. FM is used in the range 88-108 MHz for high quality broadcasting; this frequency range is within a band known as the Very High Frequency (VHF) band.

Fig 1-9: Comparison between AM and FM signals

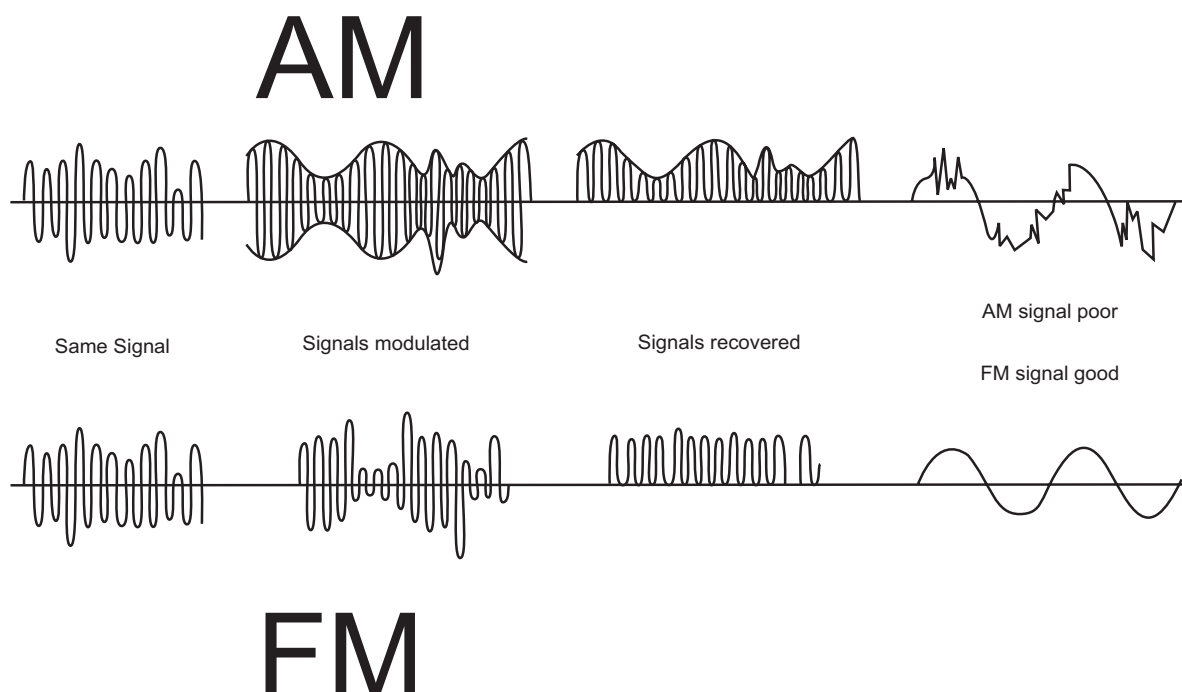

Self Assessment Questions

Do not mark this page in any way! Write your answers on a separate piece of paper

1. What is the speed of light ?
 - a. $3 \times 10^8 \text{ ms}^{-1}$
 - b. $3 \times 10^6 \text{ ms}^{-1}$
 - c. $30 \times 10^9 \text{ ms}^{-1}$
 - d. $30 \times 10^1 \text{ ms}^{-1}$

2. The relationship between frequency (f), wavelength (λ) and velocity of light (v) is given in the formula:
 - a. velocity = frequency x wavelength ($v = f \times \lambda$)
 - b. velocity = frequency + wavelength ($v = f + \lambda$)
 - c. velocity = frequency - wavelength ($v = f - \lambda$)
 - d. frequency = velocity - wavelength ($f = v - \lambda$)

3. If the velocity of radio waves is 3×10^8 , what would be the value of λ for a frequency of 3×10^6 ?
 - a. 1000m
 - b. 10m
 - c. 100m
 - d. 1m

4. What does the abbreviation SSB stand for ?
 - a. Single Side Band
 - b. Single Silicone Band
 - c. Ship to Shore Broadcast
 - d. Solo Side Band

CHAPTER 2

RECEIVERS

Purpose of an aerial

1. The first element in the process of receiving a radio message is the aerial. An aerial can vary from a length of wire supported off the ground to a complex array designed to select only certain frequencies, but whatever its shape, its purpose is to detect the tiny amounts of 'em' energy radiated from the transmitter.

How does an aerial work?

'Em' waves induce very small voltages

2. If an aerial in the form of a length of wire is placed into an electromagnetic field, tiny voltages are induced in it. These voltages alternate with the frequency of the 'em' radiation and are passed to the receiver circuitry for processing. The signal strength that the aerial inputs to the receiver is very tiny the order of 5 μ (micro) volts (0.000005 volts). Therefore the receiver circuits have to be extremely sensitive. The circuits must also isolate the wanted signal from all the unwanted ones being received, and this is achieved by using tuned circuits. A tuned circuit simply allows a single frequency to pass, thus filtering out all the unwanted signals. The best known version of a tuned circuit is the "crystal set" or "cat's whisker" as it was called in the 1920's and 30's.

Fig 2-1: The Crystal Set receiver

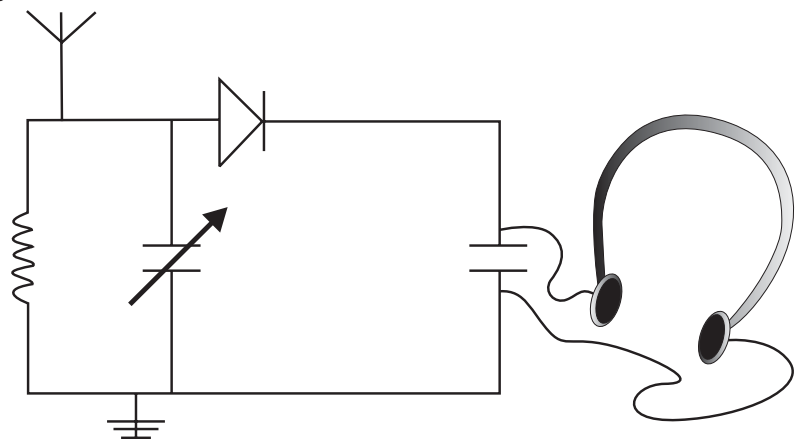
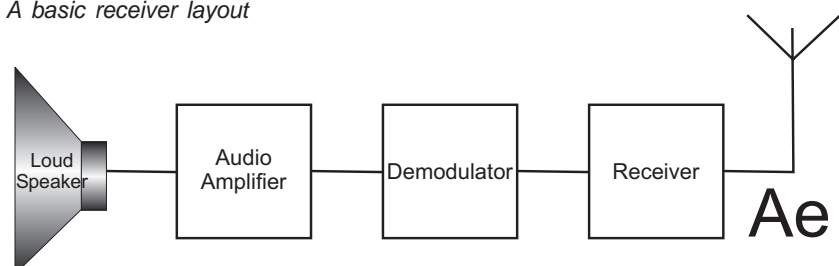

Fig 2-2: A basic receiver layout



Superhet Receivers

3. In those early models of receiver the problems encountered were noise (too much interference), poor amplification, limited selectivity, poor sensitivity (ability to remain on a station) and lack of fidelity (quality of sound).

Heterodyne receivers uses beats

4. To overcome some of these problems, the superheterodyne (superhet) receiver was developed. Heterodyne is the term used to describe the mixing of one frequency with a slightly different frequency to produce something called "beats".

5. If two notes of nearly equal frequency are sounded together, a periodic rise and fall in intensity (i.e. a beat) can be heard. You can sometimes hear this when a twin-engined propeller-driven aircraft flies overhead. If the pilot has not adjusted the engines to identical rpm, you hear a "wow-wow" instead of a steady note. The beat frequency is always the numerical difference between the two frequencies. For example, if an audio note of 48 Hz is sounded together with one of 56 Hz then the rhythmic beat of 8 Hz (56 - 48) would be heard.

Fig 2-3: Beat diagram showing softer and louder tones

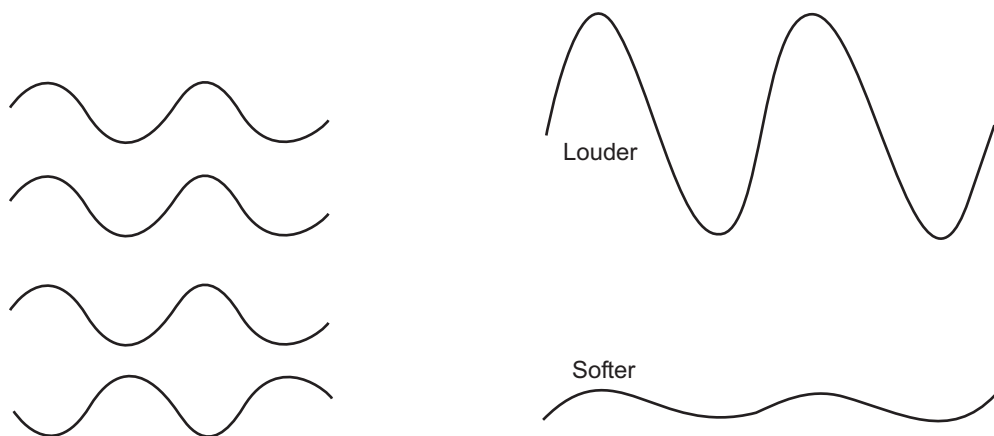

The same applies to radio waves, where the beat becomes an added frequency known as an intermediate frequency (IF). If a radio frequency (RF) signal with a frequency of 3,550 MHz is received and mixed with an IF of 3.551 MHz (1 KHz higher), a beat frequency of 1 KHz would be the result. This lower radio frequency can now be processed more effectively by the receiver's electronic circuits than the higher radio frequencies. The schematic at Fig 2-4 shows the components of a typical superhet receiver.

Fig 2-4: A superhet receiver

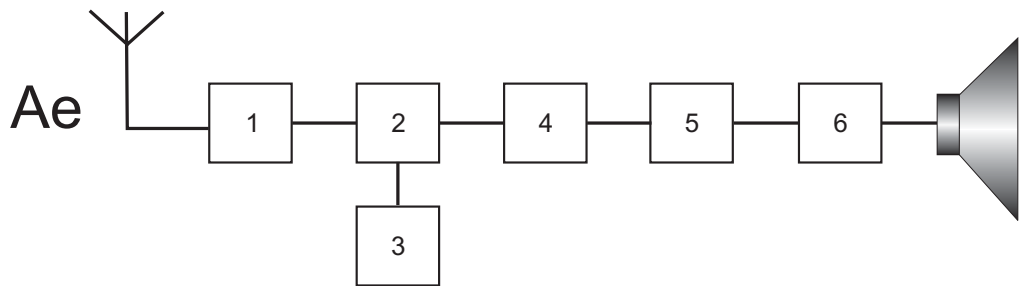

- 1 RF Amplifier** *improves sensitivity and selectivity (not used on all receivers).*
- 2 Mixer** *changes the frequency, combines incoming with the Local Oscillator (LO) to give Intermediate Frequency (IF).*
- 3 LO** *produces a constant frequency (different from incoming).*
- 4 IF Amplifier** *usually 2 or more stages. Amplifies the mixer output (gives most of gain).*
- 5 Demodulator (detector)** *extracts the intelligence from the RF signal.*
- 6 Audio Frequency Amplifier** *increases the signal to required levels of output devices (speaker / headphones).*

FM receivers use discriminators

FM Receivers

6. Reception on the AM bands is limited in both quality of reproduction and bandwidth availability. FM systems are less likely to be affected by "noise" and give increased signal performance. The FM receiver circuitry is similar to the AM system but uses a discriminator (also called a ratio detector) in place of a demodulator. The discriminator is a circuit which has been designed to detect small differences in frequencies. These differences are converted to a voltage output that represents the AF component input.

Fig 2-5: FM signal recovery through use of a ratio detector

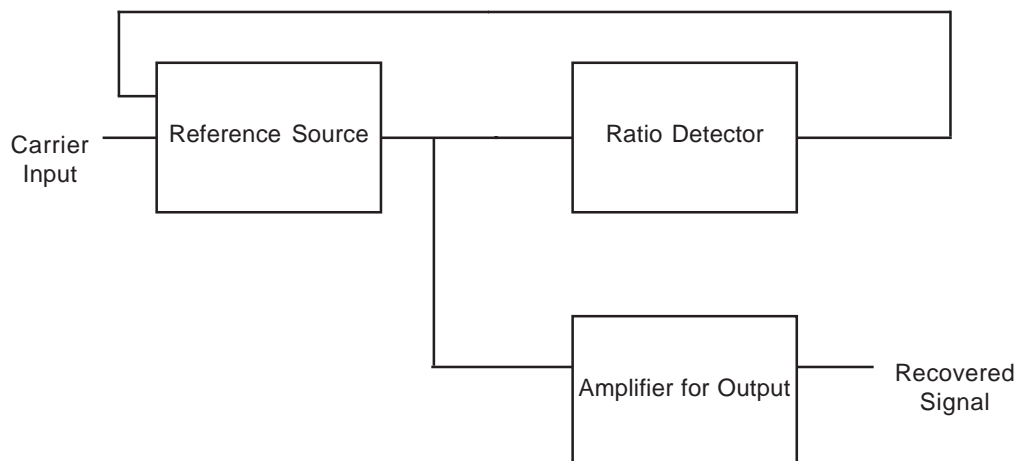

Self Assessment Questions

***Do not mark this page
in any way! Write your
answers on a
separate piece of
paper***

1. What is the purpose of an aerial on a receiver?
 - a. To convert the electromagnetic waves ('em') into tiny voltages
 - b. To convert the electromagnetic waves ('em') into large voltages
 - c. To convert the electromagnetic waves ('em') into very large voltages
 - d. To convert the electromagnetic waves ('em') into a constant voltage

2. What does superheterodyne receivers make use of?
 - a. Bleats
 - b. Boats
 - c. Beats
 - d. Bullets

3. What do FM receivers use to demodulate signals?
 - a. Distractor
 - b. Modulator
 - c. Discriminator
 - d. Disputer

CHAPTER 3

RADAR

RDF becomes Radar

1. As World War II approached, scientists and the military were keen to find a method of detecting aircraft outside the normal range of eyes and ears. They found one, and at first called it Radio Detection Finding (RDF), then RAdio Detection And Ranging (RADAR). Radar works by firing powerful radio waves towards the target, and collecting the reflected energy. The radar operators can then find the position of the target in terms of its range (i.e. distance) and bearing from the radar installation. Radar equipments can also find another vital fact about a target aircraft – its height. The radar equipment displays the information for the operator on a screen similar to that found in a television.

Fig 3-1: How radar uses reflected energy to detect targets

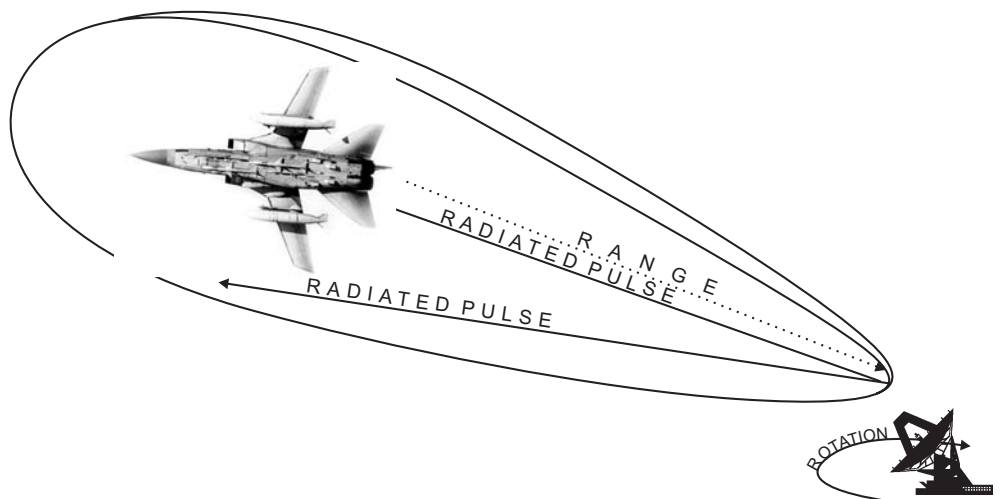

Primary and Secondary radar

2. There are basically two different types of radar, namely primary and secondary, and we will look at each in turn. Primary radar relies solely on energy that it has generated and radiated being reflected from the target - i.e. an echo, whereas Secondary radar has some co-operation from the target – the target generates its own 'em' radiation.

CHAPTER 3

Primary Radar**Primary radar uses reflected energy**

3. Primary radar systems may be found in ground, air, ship or space platforms and are used in roles such as:

Surveillance (including weather)

Early warning

Navigation

Ground mapping (from space or aircraft)

Guidance control

Target detection and tracking

Terrain following/avoidance

Collision avoidance and altitude measurement

Air Traffic Control

How it Works**Pulsed and CW**

4. Radars operate their high-powered radio waves in 2 different modes: pulse-modulated (pulsed) and continuous wave (CW).

Frequency

5. Most radars operate in the Ultra High Frequency (UHF) or Super High Frequency (SHF) bands. The Frequency of operation will depend on the function the radar is to perform, for example, a long range search radar will operate on a relatively low frequency, while a weapons system fire control radar will operate at a very high frequency.

Pulse-Modulated**Radar mile**

6. A pulsed radar uses an echo principle. In other words, the transmitter fires a very brief pulse of energy and then "listens" for an echo to return. The speed of radio waves in free space, as we know is 3×10^8 ms⁻¹ (186,000 miles per second). So if we measure the elapsed time between the transmission of the pulse and its reception back at the radar, we can use the formula:

Distance = Speed x Time

To calculate the distance to the target, the time taken for a pulse to travel one mile and return to the radar is known as a "Radar Mile". The following table shows the times for some basic units of distance:

Radar Timetable

Range of Target	Range in metres or feet	Time for return of Echo	Approximate Time for rough caluculations
1 Kilometre	1000 m	6.67 ms	6 ms (6 x 10 ⁻⁶)
1 Statute Mile	5280 ft	10.75 ms	10 ms (10 x 10 ⁻⁶)
1 Nautical Mile	6080 ft	12.36 ms	12 ms (12 x 10 ⁻⁶)

Pulse repetition frequency

7. The pulses from a radar are transmitted at a rate which determines the range of the radar, called the pulse repetition frequency or PRF.

Fig 3-2: Peak power wave form in a PRF signal

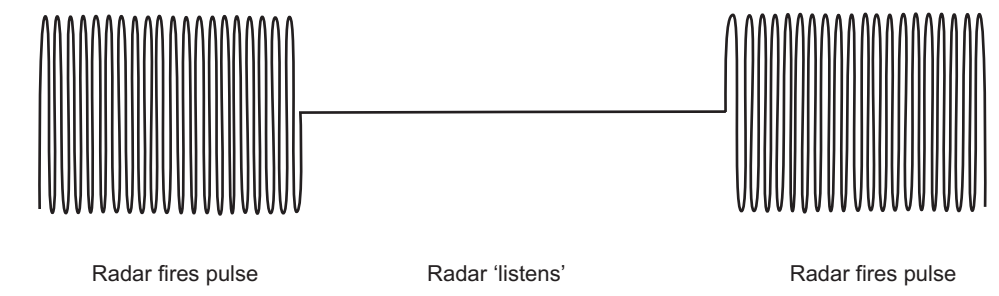

8. In practice the PRF might range from 250pps for long-range radars to 2000pps for short-range radars. For long-range radar, to get a satisfactory return from a pulse, a massive one million watts (megawatt) of radio frequency (RF) power is required. This high power is used only during the brief transmission of the pulse. The transmitter is then allowed to rest until the next pulse (as shown in Fig 3-2), and the receiver meanwhile is listening for an echo.

Continuous Wave Radar (CW)

9. There are two basic types of CW radar. These are called CW Doppler and frequency-modulated CW (FMCW).

CW Doppler**Radar using Doppler effect**

10. Consider the situation where a radar equipment sends out a pulse of radio waves and then "listens" for an echo. If the target is moving towards the transmitter

the reflected waves become bunched up (i.e. they acquire a higher frequency), due to the target's velocity. If the target is moving away, the waves are spread out and their frequency drops slightly. A similar effect can be experienced with sound waves. When a racing car approaches, you hear the pitch of the sound getting higher (sound waves bunching up) until it passes. Then the pitch suddenly drops lower (sound waves spreading out). This is called the Doppler effect. The radar equipment is able to detect these small changes in frequency (or shifts) and so determine the target's velocity with respect to the transmitter. A similar system is used by traffic police with their "speed gun".

11. Of course, a target rarely approaches the radar installation head-on and in the diagram below, the target's track (AC) is at an angle to its bearing from the radar (AB). The velocity in direction AB is less than the true target speed in direction AC. However, by comparing changes in Doppler shift at the radar receiver over a short period, the target's velocity can be calculated.

Fig 3-3: How Doppler frequency shift is used

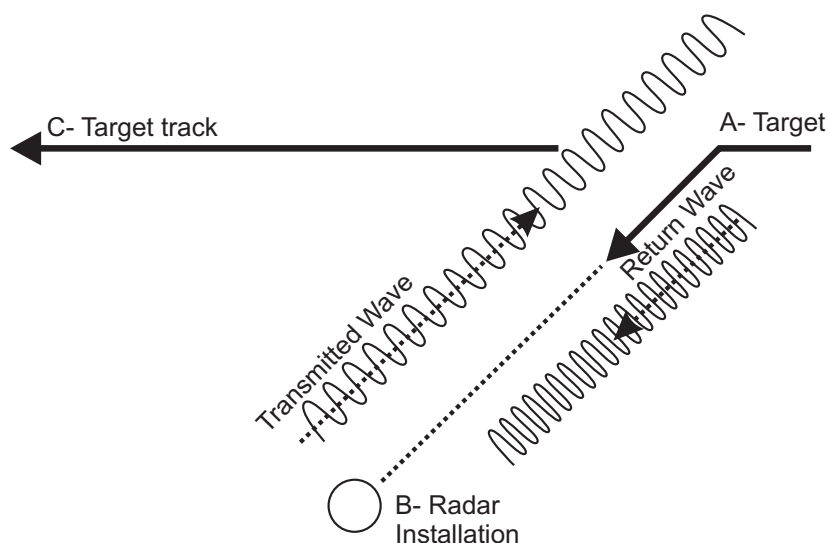

FMCW

12. In the case of FMCW, the transmitter's signal is made to vary in frequency in a controlled cyclic manner with respect to time, over a fixed band. By measuring the frequency of the returning echo it is possible to calculate the time interval elapsed since that frequency was transmitted, and thus the target's range.

Secondary Radar

IFF and SSR

13. It is vital to know the identity of an aircraft displayed on an air traffic controller's screen, particularly in a military situation. A method of identifying aircraft was first used in the second World War and called Identification Friend or Foe (IFF). It is still in use today. It works by fitting all friendly aircraft with a transmitter/receiver (called a transponder) which can send a reply signal to an interrogating transmitter/ receiver (an interrogator). On the ground the system is co-located with the primary radar, but does not require as much power because the radio waves have only to travel one way – the aircraft replies with its own onboard transmitter. The IFF equipment is specifically for military use, but a civilian version does exist, called Secondary Surveillance Radar (SSR). Both systems are compatible with the groundbased interrogators which use a transmission frequency of 1030 MHz, while aircraft transponders use 1090 MHz.

SSR modes

14. The IFF/SSR systems have been developed so that specific information can be obtained from an aircraft. The aircraft is interrogated on 1030 MHz using coded pulses or modes. Similarly, the aircraft will respond on 1090 MHz using a standard system of codes. There are 3 modes in use and they are:

Mode 1	Military Aircraft Identify
Mode 2	Military Mission Identify
Mode 3	A Common Military/Civilian Aircraft Identify
	B Civil Identify
	C Height Encoded Data

15. IFF/SSR system provide ATC authorities with a wealth of information about particular aircraft – far exceeding the amount of information gained by simply using a primary radar. The types of information available are:

- Aircraft height (direct from aircraft's altimeter)
- Direction
- Speed
- Type of aircraft

CHAPTER 3

16. The aircraft can also send emergency information such as:

Loss of radio communications (code 7600)

Hijack (code 7500)

SOS (code 7700)

Advantages of SSR

17. The main advantages of IFF/SSR over primary radar are:

a. No clutter problems (i.e. unwanted returns from rain clouds and mountains) since transmitter and receiver operate on different frequencies.

b. Increased range with less transmitted power, as the radio waves only have to travel one way.

c. More information from each target.

d. Ability to use wide bandwidth receivers.

18. SSR has become an indispensable component in Air Traffic and Air Defence systems because an aircraft not using SSR is less easily observed, and presents a potential collision hazard.

Aerials

19. As you know, a simple aerial can consist of a piece of wire which, when transmitting, will radiate electromagnetic waves equally in all directions. Similarly, a simple piece of wire will receive signals from all directions. This is of limited use when trying to determine the direction of a particular reflection. Instead, the waves need to be concentrated into a beam so that the radar can be made to "look" and "listen" in one specific direction at a time.

Directing the radiation beam

20. Focusing radio waves into a beam requires a much more complicated aerial system than a simple straight wire. In order to produce a beam of radiation we need

to radiate from a shaped area, and not a single wire. In theory, this means that for long wavelengths great areas of aerial would be needed. To overcome this problem, reflectors are used on the aerial to reflect the radio waves in one direction. The situation is very similar to the reflector in a torch or headlight focusing the light into a narrow beam. To detect accurate bearings of aircraft the aerial is rotated through 360° , sweeping a narrow beam of radiation in a complete circle (called scanning). All reflections can now be plotted around a circle – with the aerial at the centre. To obtain vertical information about the aircraft the aerial is moved up and down through 90° – in a type of nodding movement. From the reflections received, accurate height and range information can be measured.

Fig 3-4: Beam patterns for differing aerial types

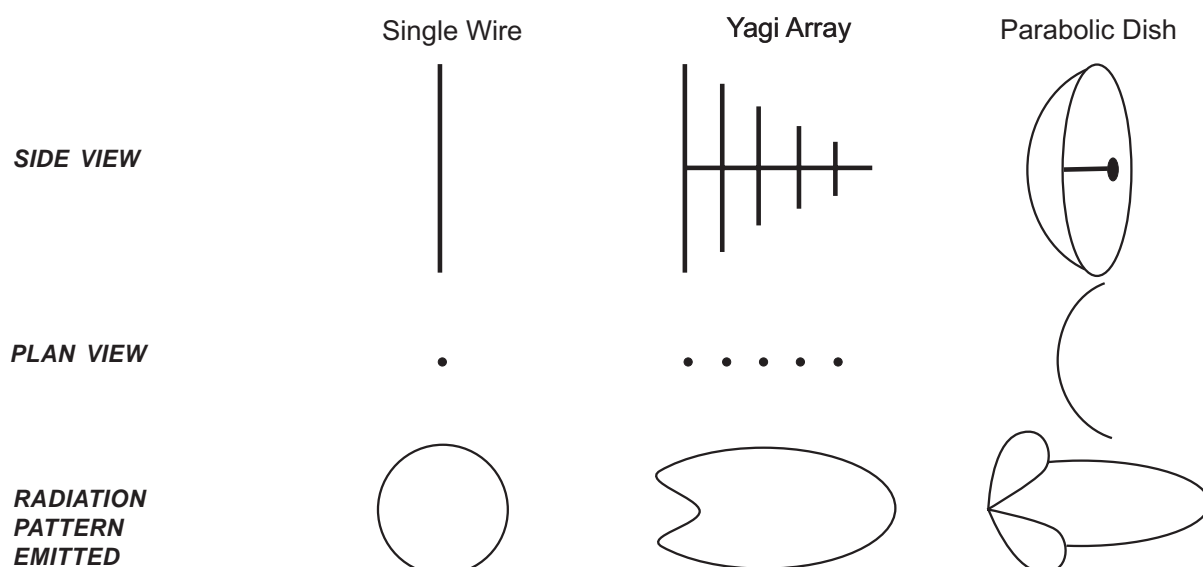

The Display

CRT display

21. Obtaining a target is only part of the detecting process. The operator needs to "see" the target in visual form. For this we use a cathode ray tube (CRT) which works on a similar principle to a television screen. As the time interval between pulses is short the screen can be calibrated in miles to match the range of the pulse.

22. At Fig 3-5, the instant the pulse is transmitted a spot appears at "A". It then travels towards "B" at a constant speed known as the "base velocity". If a target is detected a "blip" appears; in this case "C". Because the screen is calibrated in miles we know the distance to the target.

CHAPTER 3

For a moving target, the blip would travel along the line "A-B". The important factor here is that the time-base of the CRT is synchronised to the start of the transmission of the radar pulse. Fig 3-6 shows the output from a Type "A" display. From the pips or marks (known as intervals) the operator can estimate the range of the target.

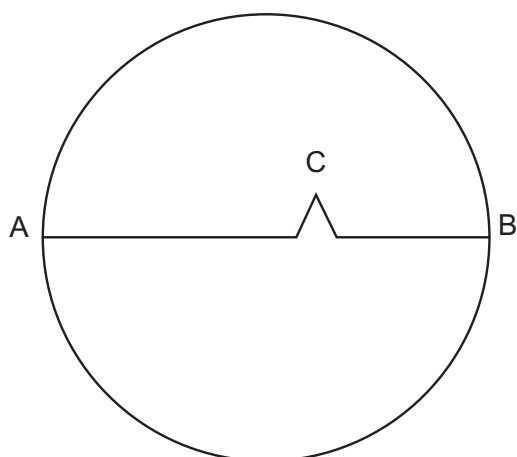

Fig 3-5 A CRT Display

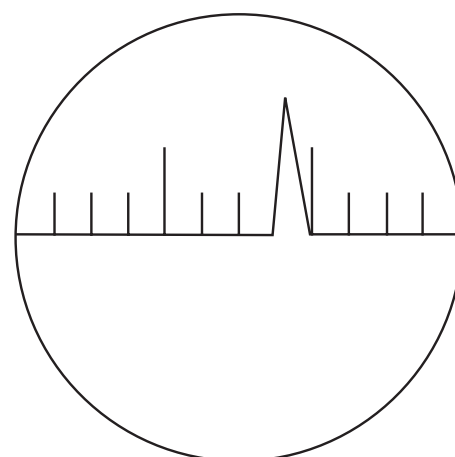

Fig 3-6 Type "A" display

Plan Position Indicator 23. To find the bearing of a target (i.e. its direction) we need to find its azimuth (bearing measured from North). By transmitting a narrow beam of radio waves and rotating it through 360°, the azimuth of any target being illuminated can be calculated. A Type "A" display shows only the range of a target, but it is possible to display both range and bearing on the same CRT by using a plan position indicator (PPI) display. The spot on the PPI displays starts from the centre of the screen and produces a radial trace. This trace moves in time with the rotation of the aerial. Range rings can be added to aid the operator in range finding.

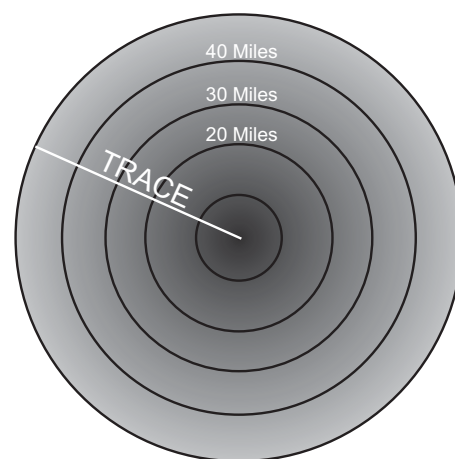
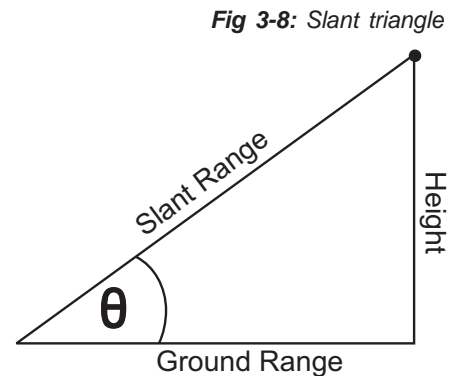

Fig 3-7 Range Rings

Slant ranges and Height

24. The height of a target can be calculated by using the slant range (distance from the radar to the target). This is calculated by using the formula

$$\text{Height} = \text{Slant Range} \times \sin \theta$$

**Ground range**

The target's ground range can be calculated by the formula:

$$\text{Ground Range} = \text{Slant Range} \times \cos \theta$$

3-D radar

25. From what you have just read, to pinpoint a target by both height and bearing requires more than one aerial. However, there is now a radar system that combines both of these facilities into one aerial, known as the 3-D. It works by electronically selecting the various aerial arrays and passing the information to the PPI display.

Factors affecting radar operations**Factors affecting radar performance**

26. There are many factors that prevent efficient operation of a radar system, such as:

- a. **Noise** – unwanted signals from radio, stars and the atmosphere.
- b. **Interference** – unwanted man-made signals such as other radar transmitters, electrical apparatus and electrical machinery. The correct siting of a radar system can reduce the effects of some of these problems.
- c. **Clutter** – unwanted echoes from hills, buildings, sea, clouds, hail, rain and snow. These false echoes will weaken real echoes from targets, but fortunately they can be reduced by electronic techniques.
- d. **Target characteristics** – a target's shape and composition will have an effect on its echo. Metal, for example, is a better reflector of radio waves

than wood or plastic – flat surfaces are better reflectors than curves. The USA's stealth fighters and bombers make use of the different reflecting capabilities of materials and shapes to effectively "hide" from enemy radars.

Radar Installation

27. This block diagram shows the components of a typical radar installation.

Fig 3-9: Radar block diagram

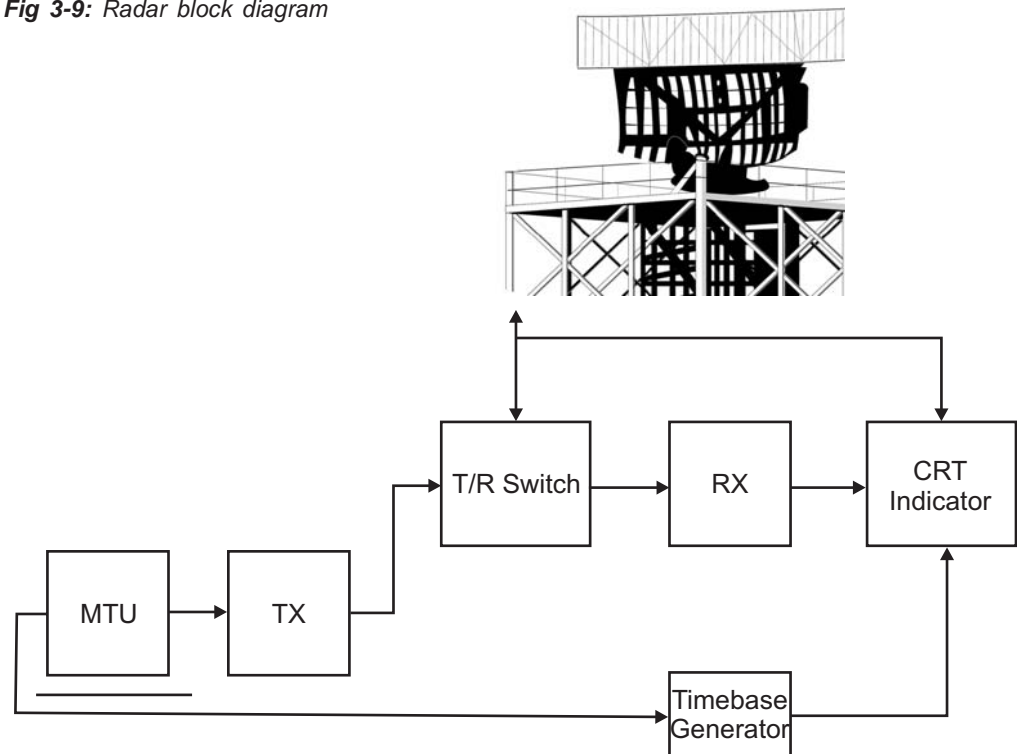

Master Timing Unit (MTU)

This unit produces regular, timed pulses. It controls the number of pulses transmitted per second and the start of the timebase generator, and it synchronises the system.

Transmitter (Tx)

The transmitter produces high energy RF pulses and determines the pulse duration. The range of frequencies used is in the order of 400 MHz to 40GHz.

Aerial

This is used to launch the RF pulses and collect the returns for processing.

Transmit/Receive (T/R) Switch

This is an electronic device that switches both the transmitter and receiver "ON" and "OFF". It is important that the receiver is disconnected with the transmitter is firing pulses (to prevent damage). On the return cycle the transmitter is disconnected while the receiver is online to prevent reflections being absorbed by the transmitter.

Receiver (Rx)

The receiver collects and amplifies the returning echoes and then produces the video pulses that are applied to the display.

CRT Indicator

The CRT indicator displays the target echoes to the operator.

Timebase Generator

This unit provides the reference signal for the start of the transmit sequence.

Self Assessment Questions

Do not mark this page in any way! Write your answers on a separate piece of paper

1. What does RADAR stand for?
 - a. Radar Detection and Ranging
 - b. Radiation Aircraft Ranging
 - c. Radio Detection and Ranging
 - d. Ranging and Direction Radio

2. How many modes are there in IFF/SSR?
 - a. 4
 - b. 1
 - c. 2
 - d. 3

3. What does SSR stand for?
 - a. Secondary Surveillance Radar
 - b. Service Surveillance Radio
 - c. Single Side Radio
 - d. Second Sense Radar

4. What does CRT stand for?
 - a. Cathode Radio Tube
 - b. Cathode Ray Tube
 - c. Cathode Radiation Test
 - d. Capacitor Resistor Transistor

5. What is the purpose of a timebase generator in a Radar?
 - a. Provides the reference signal to start the transmit sequence
 - b. Synchronise the T/R switch
 - c. Provide a reference signal for the receiver
 - d. Used to launch the pulses and collect them on return

CHAPTER 4

Equipments

1. We have already looked at the general principle of operation of both radio communication and radar. In this Chapter we will look more closely at a variety of different types of equipment used in the RAF, to see how and where they are used.

Precision Approach Radar (PAR)

PAR

2. The purpose of PAR is to plot the approach of an aircraft wishing to land and allow ATC to give accurate guidance to the pilot to achieve a safe landing. The system can be used in poor weather conditions (i.e. low cloud, limited visibility), thus reducing interruptions to a station's flying programme.

Fig 4-1: A typical layout of a PAR cabin

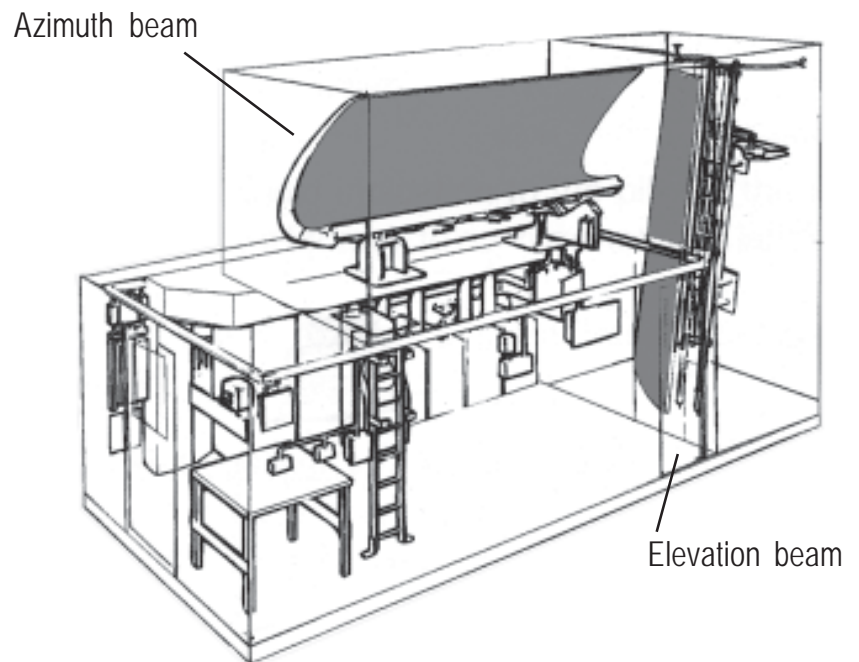

3. PAR consists of a Radar Head cabin connected to the ATC operations cell in the control tower. The Radar Head is mounted on a strong framework and can rotate around a central point. This means the cabin can be turned to serve whichever runway is in use. The turning mechanism can be operated remotely from the operation cell in ATC, or manually in the cabin itself.

CHAPTER 4

The radar head

4. The Radar Head has 3 distinctive assemblies – the Azimuth antenna module, the Elevation module and the Radar Cabin. PAR offers the facility of allowing the safe approach in bad weather to a point where the pilot's "visual" acquisition of the runway allows a safe landing. It can guide pilots to the runway from up to 15 nautical miles away.

Principle of Operation**Cross shaped beam**

5. A narrow wedge shaped beam is transmitted from both PAR antennas. One is a horizontal beam (2° wide by 0.5° high) and the other a vertical beam (0.5° wide by 2° high). These beams are then interlocked to give a cross shaped beam. The scanning motion is controlled by the ATC operator in the control tower and allows the aircraft to be "captured" in the beam pattern. This information is then displayed to the controller on a screen with two displays. One display is of the elevation scan, the other shows the azimuth scan. Using both of these displays the controller is able to guide the aircraft down a safe "glide path" to approach the runway on the correct course.

Fig 4-2: Aircraft are caught in the cross beams

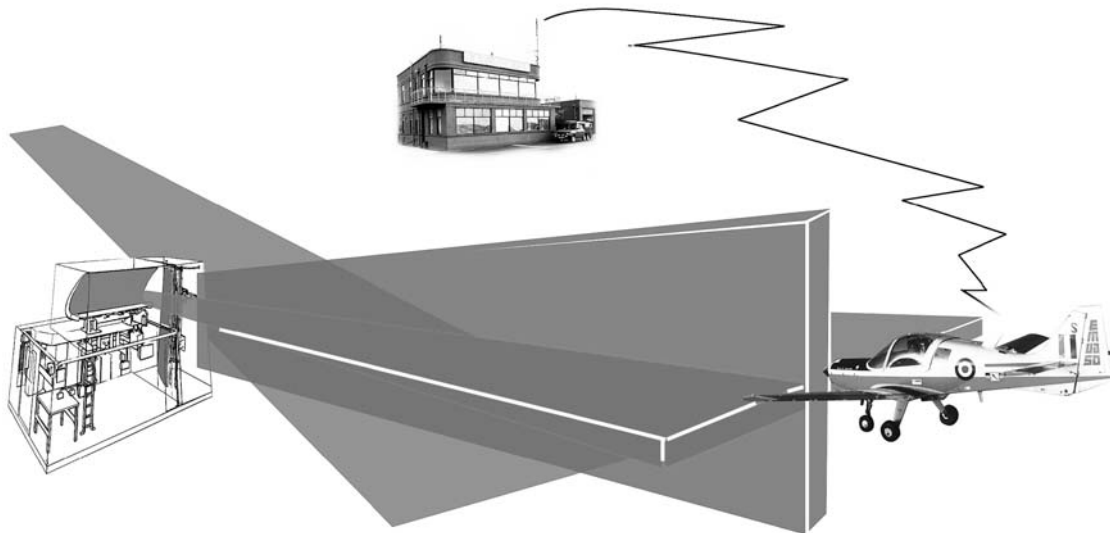
Instrument Landing System (ILS)**ILS**

6. The ILS is a pilot-interpreted system which provides accurate guidance to the runway for a safe landing without a ground controller.

7. An ILS ground installation is situated near the runway. It transmits signals that allow a pilot (who is on a landing approach) to accurately locate the aircraft's position relative to the touchdown point. These signals provide the pilot with:
 - a. A visual indication (on a cockpit instrument) of the aircraft's azimuth relative to the runway centre line.
 - b. A visual indication (on the same cockpit instrument) of the aircraft's elevation in relation to the correct descent angle.
 - c. Both an audio (via radio headset) and visual (a flashing light on the cockpit instrument) indication of the aircraft's distance from touch down.

Fig 4-3: A plan view of ILS

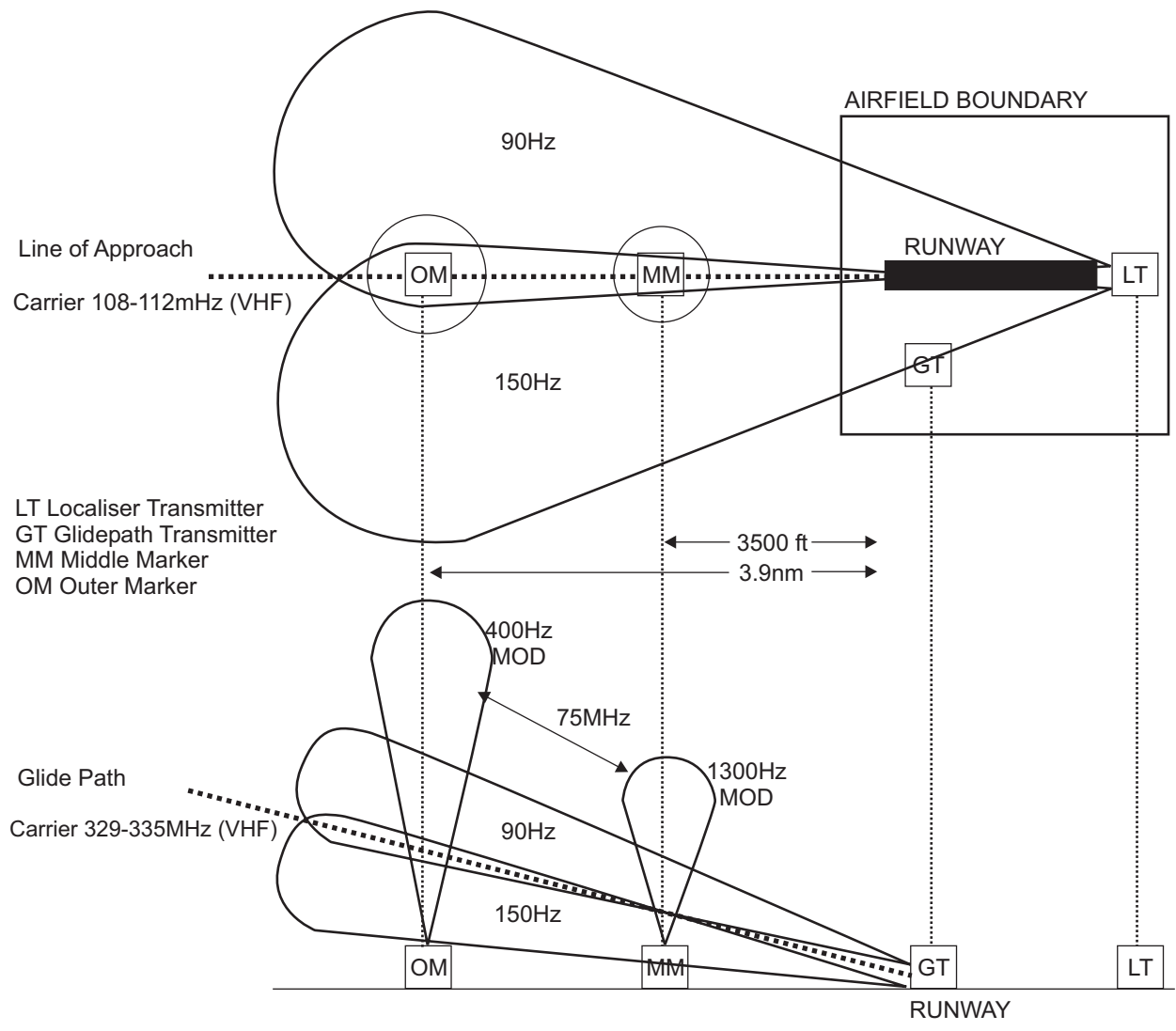

CHAPTER 4

d. An audio indication to the pilot of the identity of the airfield ahead (in Morse code), to confirm that he is landing at the right airfield!

3 elements of ILS

8. The ILS ground system has 3 separate elements, each providing different information:

Localiser

a. **Localiser.** The localiser gives azimuth and airfield identification information (7a and 7d above), and it is installed usually some 1,000 ft beyond the upwind end of the instrument runway.

Glide path

b. **Glide Path.** The glide path gives elevation information (7b), and is installed slightly to one side of the runway, near the ideal touch-down point.

Marker beacons

c. **Marker Beacons.** The marker beacons give range information, by "telling" the pilot when he is over them (7c). They are installed in a direct line with the centre line of the runway, as follows:

(1) Outer Marker. This is located at a point where the glide slope and the landing pattern intersect (typically 5 nm from the end of the runway).

(2) Middle Marker. This is located on line with the localiser (typically 1/2 to 3/4 miles from the end of the runway).

(3) Inner Marker. This is installed in very few systems. If used it would be positioned at the beginning of the runway.

9. To use the ILS a pilot must position the aircraft (using radar or other means) in line with the instrument runway at a range of some 20 to 25 miles. As he flies towards the runway, first, he passes over the outer marker which "tells" him he has 5 miles to go. Second, the localiser and glide-path beams will be giving indications on the cockpit instruments, and the pilot has total ILS guidance, with which he can safely proceed on instruments towards touchdown. Third, the middle marker warns that there is 3/4 miles or less to the runway. Shortly after, fourth, the pilot should be able to see the runway to land visually.

Principles of Operation

10. The instrument that gives the pilot visual indications is a meter with two pointers. One pointer indicates in which direction to fly (left or right), to align with the runway centre line. The other pointer indicates in which direction to fly (up or down), to align with the correct glide-path. When the two pointers cross at the centre of the display it indicates that the aircraft is on the glide-path and the correct heading for landing. The instrument also has warning flags which remain "set" until there is sufficient signal strength for the system to operate. There are also 'dots' on the display, to help the pilot in determining the flight path adjustments required to gain the correct approach angle or direction.

Fig 4-5: How the glidepath looks to the pilot

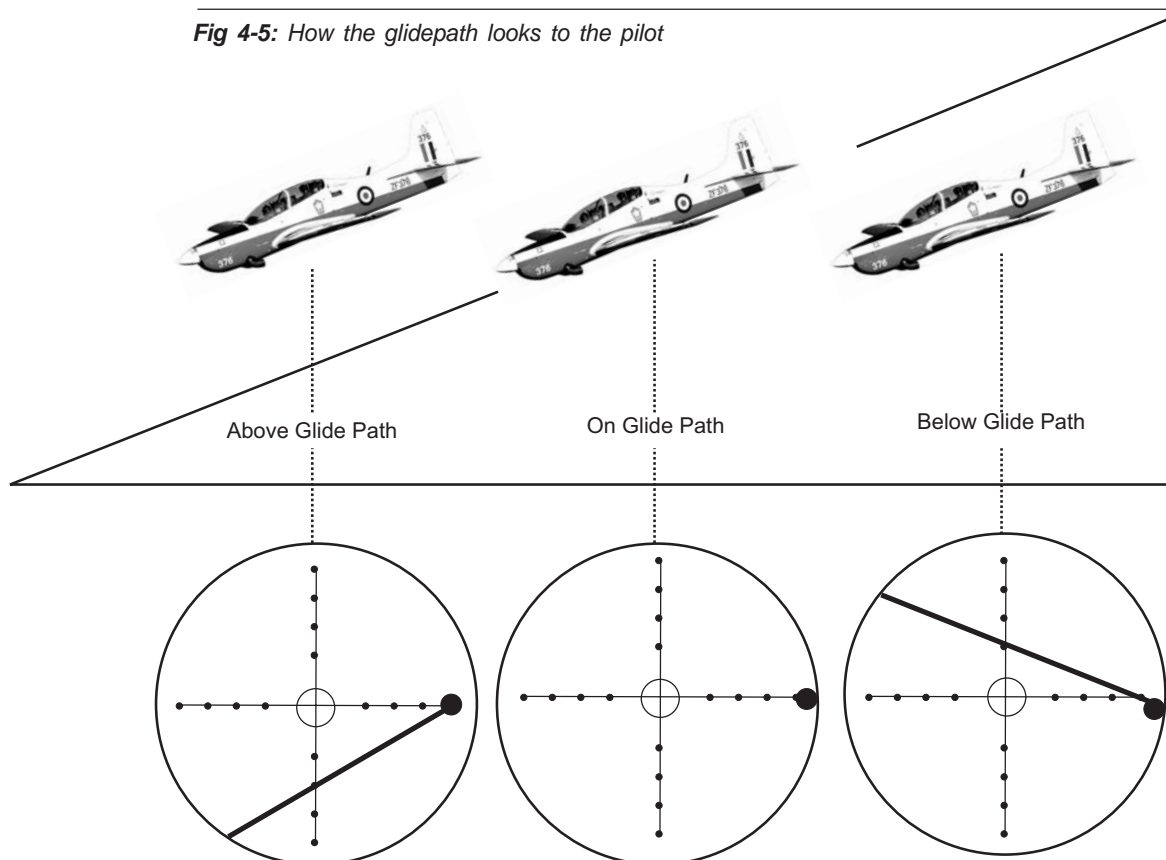

11. The localiser radiates two radio beams, one modulated at 90 Hz frequency and the other modulated at 150 Hz. If the aircraft is 'off' course to the left, 90 Hz is dominant and the azimuth pointer on the cockpit instrument moves to the right. If the aircraft is 'off' course to the right of the centre line, 150 Hz is dominant. If the pilot is on course, the instrument shows no difference in the signal, by aligning with the centre of the dial.

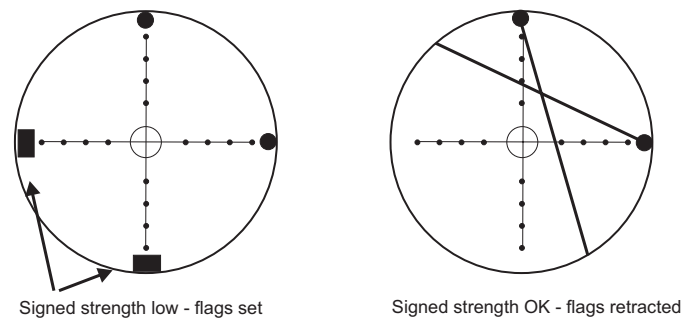
Fig 4-6: The ILS pointers in an aircraft cockpit

Similarly, the glide path equipment transmits 2 radio beams modulated at 90 Hz and 150 Hz and the pilot can tell whether the aircraft is too high or too low from the glide path pointer, which reacts to the strengths of the signal received (see Fig: 4-6).

ICAO standards

12. ILS is an important tool for safe handling of aircraft during the landing stage of flight. All ILS installations must conform to International Civil Aviation Organisation (ICAO) standards. These standards are high for the best reasons – safety.

Fig 4-7: The ILS localiser aerial (note the photograph shows a technicians training setup. There would be no office block at a real site)

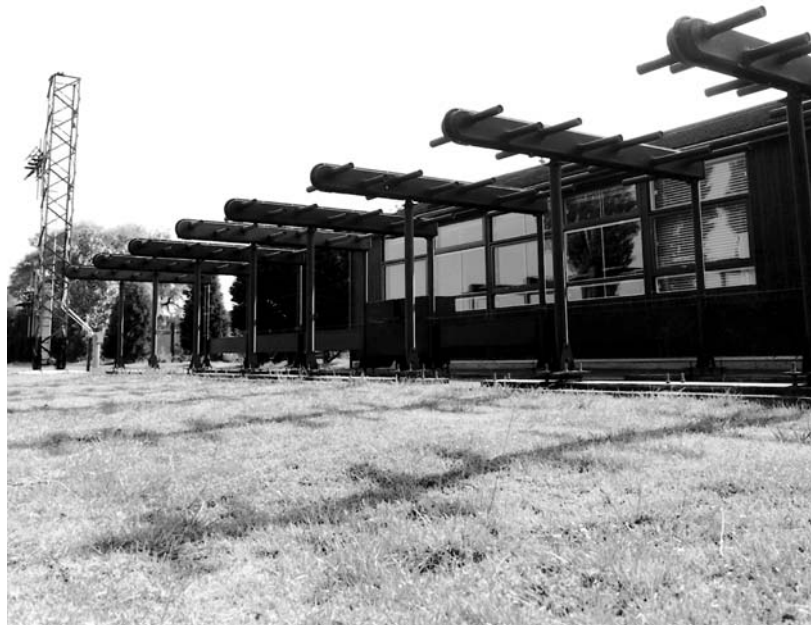
**DRDF**Digital Resolution Direction Finding (DRDF)

14. When used as a primary aid, this ground-based equipment provides a direction fix for aircraft, but it can also be used as a backup navigation aid, or as an auto-triangulation system.

Fig 4-8: A typical DRDF equipment site

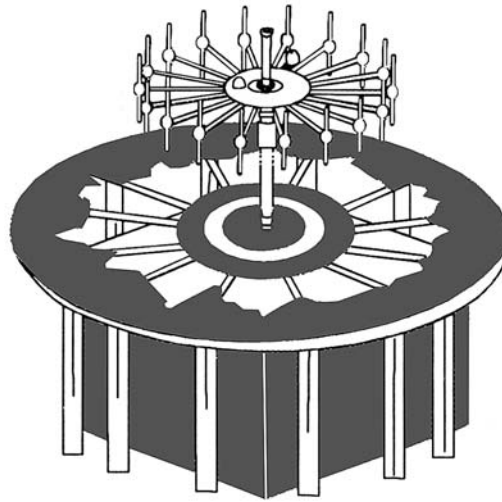
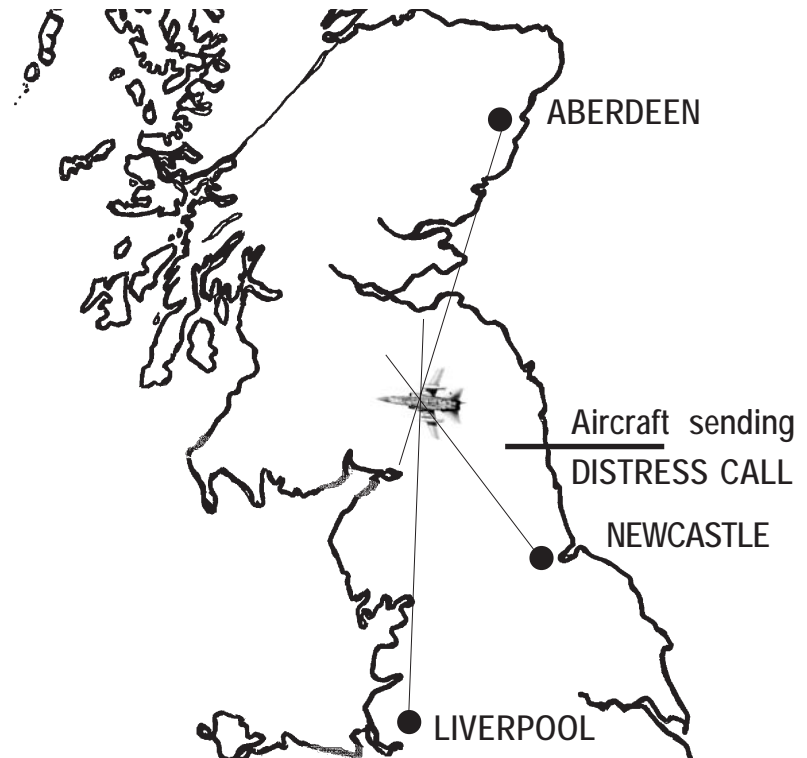

Fig 4-9: How triangulation is used to locate aircraft in distress



15. DRDF provides the controller with information on bearings of aircraft in the following forms:

Vectors

a. Digital pulses are used to give a digital read-out and a vector display.

Bearing

b. Direct Current (DC) voltage proportional to the angle of the bearing.

CHAPTER 4

This is displayed on the operator's console.

Auto-triangulation

c. Digital pulses are combined with information from other installations to provide an exact aircraft position on a large scale map that is situated at one of the UK's two main control centres (this is auto-triangulation).

Principle of Operation**Centres at Prestwick and West Drayton**

16. The DRDF is used primarily for aircraft in distress, and it helps air traffic controllers pinpoint an aircraft accurately. The 'distressed' aircraft will transmit a code which is detected by a DRDF station and used to determine a directional bearing of the aircraft. This information is passed to a main control centre, which uses similar information from other installations to triangulate the aircraft's position. There are two control centres in the UK, one is at West Drayton and the other is at Prestwick – both serving as 'hubs' to a network of outstations.

TACAN**TACAN**

17. A Tactical Air Navigation (TACAN) beacon operates as a transponder by providing regular transmissions of bearing information. This information, the identity and range of the beacon, is available to all aircraft within a 200 miles range of it. Any aircraft fitted with the correct equipment can interrogate the beacon. One TACAN can give accurate bearing, distance and identification information to 100 (correctly equipped) aircraft simultaneously.

Brief System Description**Distance and bearing**

18. Cockpit instruments indicate the range and bearing of the beacon from the aircraft, which the aircrew use to fix the aircraft's position. The beacon also transmits an identification code, so the aircrew can identify which beacon is being used. For TACAN to operate as a complete system, both ground and airborne installations are required. The ground installation contains a transmitter/receiver and an antenna array. When the ground base receives and decodes incoming signals from aircraft it then initiates a response sequence. The beacon also provides an identification morse code signal at fixed intervals.

**Aircraft interrogates
TACAN**Principle of Operation

19. The request for distance information is generated in the aircraft by distance interrogation signals (DIS). These DIS signals are randomly-generated codes which are sent to the beacon. The beacon receives the code and immediately re-transmits it back to the aircraft. The installation in the aircraft waits for the reply to its code – it can calculate its distance from the beacon by the time taken between transmission and reception. Then the information is displayed on a meter in front of the pilot. To measure the compass bearing from aircraft to beacon, the TACAN transmits a 15 Hz signal – rotated through 360°. This signal has a power peak as it passes through East. The aircraft equipment uses this as a reference to calculate where it is in relation to North, see Fig 4-11.

Fig 4-10: TACAN provides bearing information

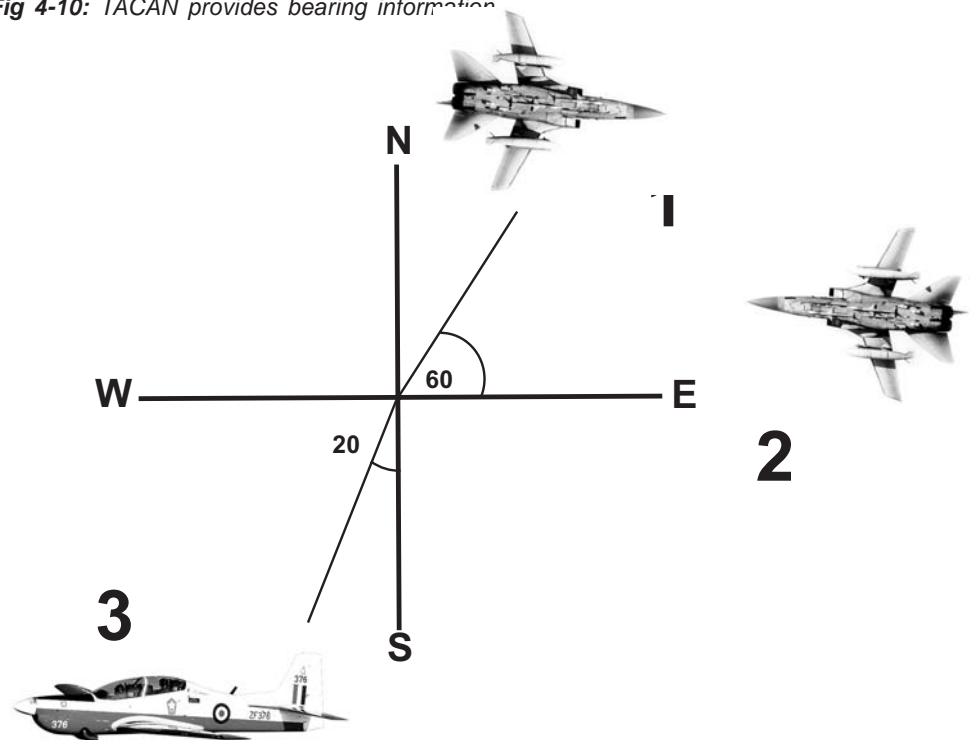

Aircraft 1 is 60° from East (in the negative) therefore the calculation is East- 60° to give a bearing of 30° with respect to North.

Aircraft 2 is at East and there is no deduction or addition so it is 90° with respect to North.

Aircraft 3 is 110° from East (in the positive) therefore the calculation is $110^\circ + 90^\circ$ to give a bearing of 200° with respect to North.

CHAPTER 4

20. TACAN is a useful navigation aid for aircraft going on long sorties because it allows pilots to fix their position accurately, and helps them to remain on course.

Airfield Communications System

Mascot Minicomms

21. It is all very well detecting the position of an aircraft using navigation aids, but controllers need to communicate effectively with the pilot. The controllers may also need to talk to emergency agencies such as fire or ambulance, in the event of an emergency. Mascot Minicomms was established as a system of communication to give controllers access to both radio and landline communications for this reason.

Patching together

22. Mascot Minicomms is the interface between many different communications systems available to the RAF and enables the ATC controller to "patch" together different support agencies. For example, in the event of an emergency, a pilot using the aircraft's radio, can talk directly to a doctor using a telephone in a hospital.

United Kingdom Air Defence Ground Environment (UKADGE)

UKADGE

23. UKADGE is a network of radars (both fixed and mobile) that together cover the whole of the UK and its airspace. Many individual sensor units such as ships or

Fig 4-11: A mobile radar provides cover where needed

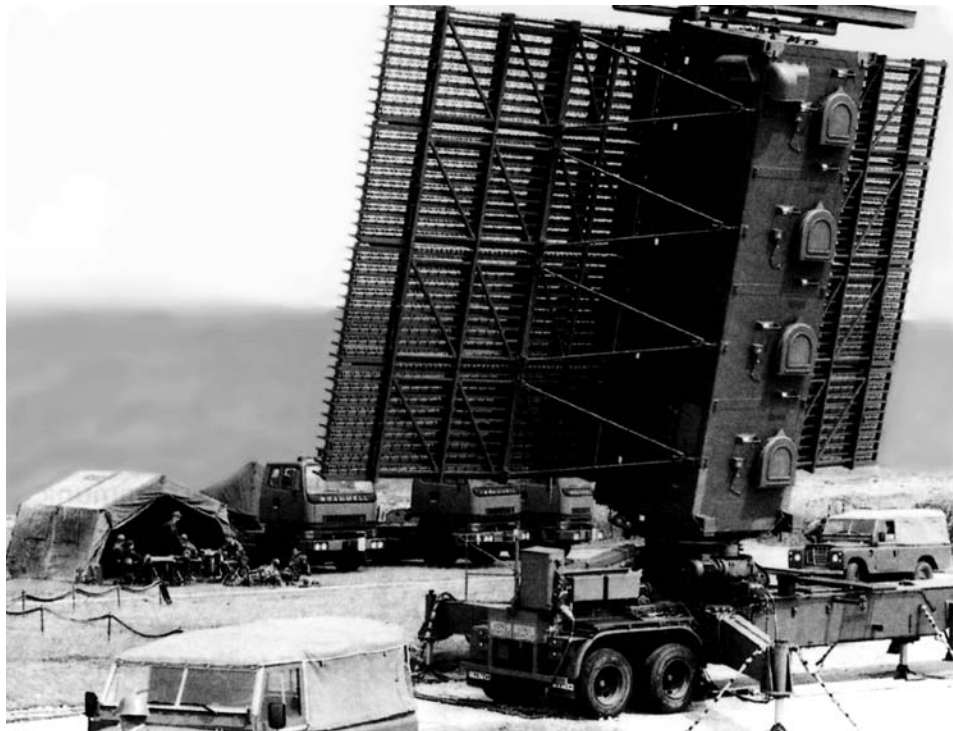

airborne early-warning aircraft, input information to the system that provides a largescale overall picture of the UK's airspace. The control centre then has the information needed to make a judgement of any threat and how to deal with it. UKADGE is one of the worlds most modern data processing and communication systems.

Defence Communications Network (DCN)

DCN

24. The DCN is a tri-service common network for communications. The types of information carried on the DCN are; operational, meteorological and administrative. This network is worldwide and uses HF radio, long-distance cables and satellites to transmit signals from sender to receiver, wherever they may be. This system is very similar to the civilian telex system or fax. A person writes a message, which is then transmitted to its destination where the recipient gets a paper copy of the message. The DCN is a modern communications system and uses computers to decide the best route through the system for the messages to take. For security reasons the messages being carried may be encrypted, so that should they be intercepted they would be unreadable to anyone who does not know the code.

Strike Command Integrated Communications System (STCICS)

STCICS

25. The STCICS system replaced the ageing HF communication system in the early 1970's. At that time the system was new and had up-to-date technology to perform its task. As the years have passed, improvements have been made to keep the equipment modern and the system in good working order. The system has two identical control centres which pass information to the 'user' units. The system provides specific services to its 'users' including:

- a. Scheduled broadcasts giving:
 - (1) Meteorological information.
 - (2) Airfield states (i.e. Is it either "open" or "closed").
- b. Flight watch – this is the initial radio contact, for aircraft that are entering UK airspace.
- c. Message switching and relay.

26. With the advent of networking technology and its availability to the RAF, the advantages in expanding the system are obvious. The system could be used more diversely, and would increase both the type and number of users.

RAF Fixed Telecommunications System (RAF FTS)

RAF FTS

27. The RAF FTS is important because it supports UKADGE in the defence of UK airspace. If a target is detected, a central control decides the action to be taken. Good communications to other operational units, support units and emergency services are essential. The RAF FTS ensures good communications between all these agencies and authorities. The systems provides for 3 areas:

- a. Voice – person to person (either secure or not)
- b. Recorded messages – written orders or signals (achieved via DCN).
- c. Data – transfer of data is important and circuits carrying data normally have dedicated lines.

28. The RAF FTS consists of a variety of different types of media used to carry information (called Boxer) and various types of equipment used to send and receive the information (called Uniter).

Boxer

Boxer – data links

29. This is the network of Service-owned lines and information links that carry information all round the country. It includes fibre optic, microwave and satellite links.

Uniter

Uniter – hardware

30. Uniter provides the switching and terminal equipment which allows the user to communicate information to a receiver. Communication will include voice, recorded messages and data as described above.

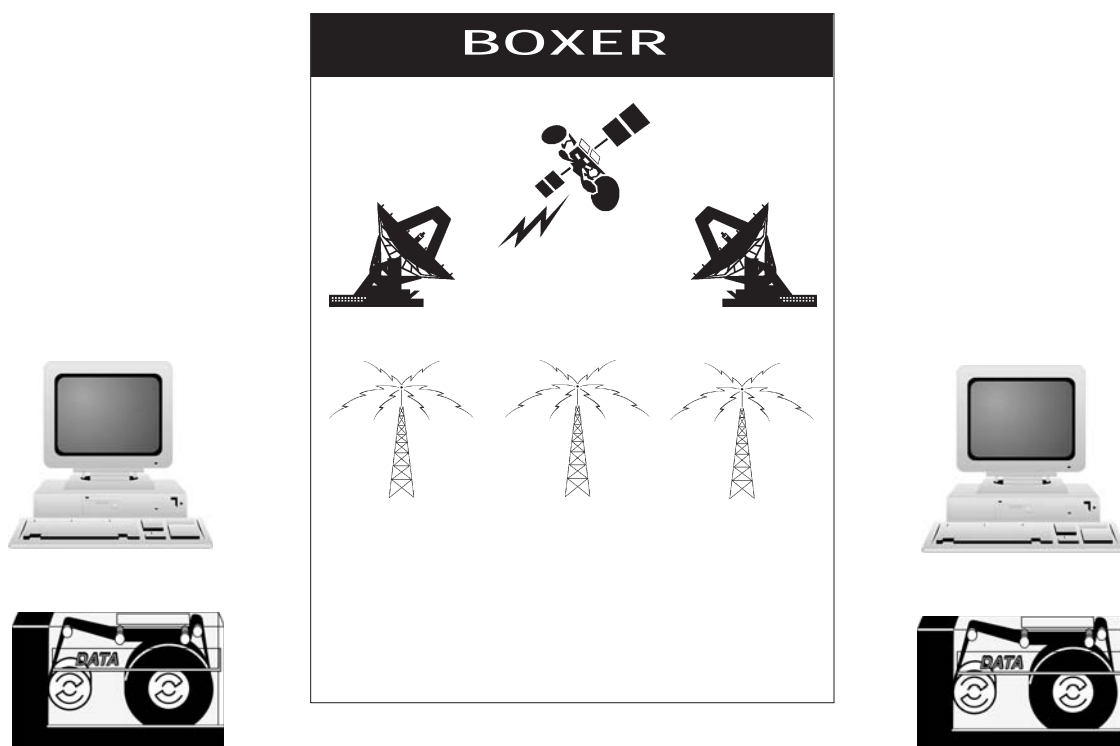

Satellite Communications

31. With the advent of reliable satellite communications and advances in new technology, the use of HF systems has reduced over recent years in preference to satellite communications. Satellite communications provides high speed data links over a much broader bandwidth. This subject area is covered more extensively in "Satellite Communications" ACP 35 Volume 4.

Self Assessment Questions

***Do not mark this page
in any way! Write your
answers on a separate
piece of paper***

1. What does PAR stand for?
 - a. Precision Approach Radar
 - b. Primary Aircraft Radar
 - c. Portable Aircraft Radar
 - d. Pin-point Approach Radar

2. What information comes from an ILS Localiser?
 - a. Height
 - b. Azimuth
 - c. Range
 - d. Elevation

3. What does TACAN stand for?
 - a. Tactical Air Communications and Networking
 - b. Technical Air Navigation
 - c. Tactical Air Navigation
 - d. Terminal Approach Radar

4. What is the name of the system that can link an ordinary telephone to an aircraft's radio?
 - a. Uniter
 - b. RF FTS
 - c. Boxer
 - d. Mascot Minicomms

5. What is the name of the air defence system used in the UK?
 - a. United Kingdom Air Defence Ground Environment
 - b. United Kingdom Defence of Air Ground Equipment
 - c. Air Defence Ground Environment (United Kingdom)
 - d. Ground Equipment for United Kingdom's Air Defence

CHAPTER 1

*Chapter 1 Para 20***Bandwidths Used in Broadcasting**

Radio transmitters used for broadcasting sound programmes in the low, medium and high wavelengths are normally amplitude modulated. These modulation frequencies are from approximately 50Hz to 5KHz. If both sidebands are broadcast then for a 5KHz signal the space occupied will be 10KHz. There are places in the world that only allow the modulation frequencies to reach a maximum of 4.5KHz, thus giving a bandwidth of 9KHz.

Frequency modulated signals for broadcast are used in VHF radio and are about 15KHz per sideband. The main difference is that the sidebands may be extended up to six times that width. This means that a broadcast may be in the order of 180KHz in width. This is due to the higher frequencies with more space.

Signal	Bass Bandwidth	Channel Bandwidth
Morse (CW)	20 Hz	100 Hz
5 Unit teleprinter	25 Hz	120 Hz
Line telephony	3.1 KHz	4 KHz
(using single sideband)		
Low quality sound	5 KHz	9 KHz
High quality sound	15 KHz	200 KHz
405 line television	3 MHz	6 MHz
625 line television	6.5 MHz	8 MHz



Chapter 2 Para 2

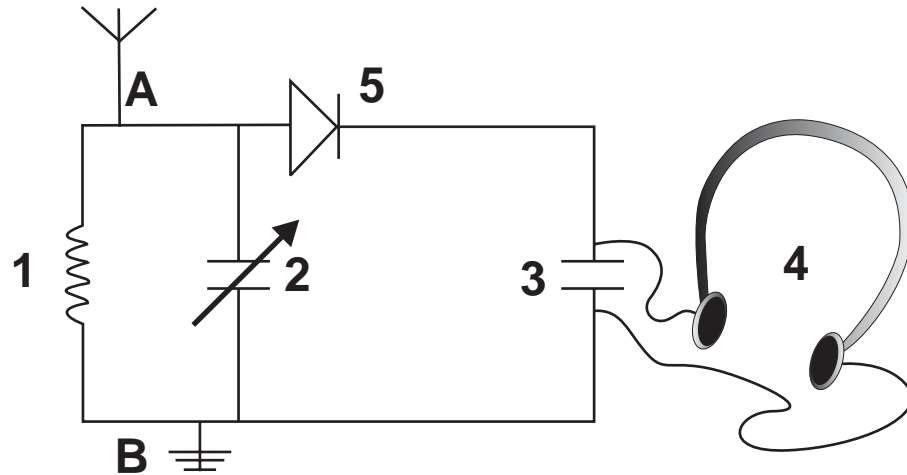

- | | |
|---|--|
| 1 | Ferrite Rod and 6" x 3/8" coil of 50 turns with insulated wire |
| 2 | 500pF Variable capacitor |
| 3 | 100pF Fixed capacitor |
| 4 | High Impedance Headphones |
| 5 | OA81 or OA91 Diode |

Fig 2-1: The Crystal Set receiver

Crystal Set Receiver

The diagram above shows a simple receiver. It is possible to build this receiver as a project or to gauge the understanding of the subject but is not mandatory.

The 'em' waves are concentrated within the ferrite rod.

The inductance produced forms a resonant circuit with the variable capacitor.

The rod has 50 turns and they are to be all wound in the same direction.

By adjusting the capacitor the resonance can be varied so stations within the medium wave band can be selected.

Demodulation is achieved by using the diode coupled with the fixed capacitor.

The headphones then convert the electrical variations into audible intelligence.

At point A, a long length of wire should be attached to act as an aerial.

The circuit should be earthed at point B, this will improve signal strength.

CHAPTER 2

*Chapter 2 Para 3***Noise**

Noise in receivers can be a very serious problem and great care is taken to eliminate it. Most types of noise have their own sound and a name to describe them by. Here are two examples:

Hum A steady note of low frequency caused by the power supply breaking through to the receiver circuitry. This is caused by poor screening.

Hiss A steady note of high frequency and can be likened to a whistle.

Noise is used in certain equipments to simulate traffic and in so doing keep the circuits active (TACAN is an example of this type of use).

Codes

Many systems have been used to communicate over distances. Perhaps the best known of these is semaphore used primarily in the Navy. The first telegraphy code was Morse Code in 1837. This code was a combination of dots and dashes and the original idea was for the receiver to "read" the message using the ear. This was later modified so that incoming messages were recorded using a device called a ticker-tape (so called because of the sound it made while punching the tape). Morse is still used today to transfer information over radio waves.

By 1874 Emile Baudot, a French inventor, had developed a new telegraphy system. Morse was exclusive because very special training was needed to understand and work the system. Baudot's system used a series of five characters (called 5 unit). This meant that every character had five dots (either blank or solid). The letter "A" would look like this ●●○○○. This code in reality is a binary system similar to those used in computers. Five (5) unit code is still heavily used today and forms the foundation for International Telegraph Alphabet Number 2 (ITA2), an international standard for communications.



INSTRUCTORS GUIDE

Chapter 3 Para 5

Frequency - UHF and SHF

Most radars operate in the ultra high frequency (UHF) or super high frequency (SHF) bands and the frequency of operation will depend on the function the radar is to perform.

Frequency Band	Frequency Range	Wavelength Range	Wavelength Band
Ultra high frequency (UHF)	300 MHz - 3 GHz	1 M - 10 cm	Decimetric
Super high frequency (SHF)	3 - 30 GHz	10 - 0.1 cm	Centimetric

TYPICAL RADAR CHARACTERISTICS

Search Radar

High peak power

Low PRF

Long pulse duration

This type is a long range radar of range 200-300 miles.

Surveillance Radar

Medium peak power

Medium PRF

Medium pulse duration

This type of radar has a range of approximately 75 miles.

Secondary Surveillance Radar

Low peak power

Pulses transmitted in coded groups

Transmission and reception are on different frequencies

CHAPTER 3

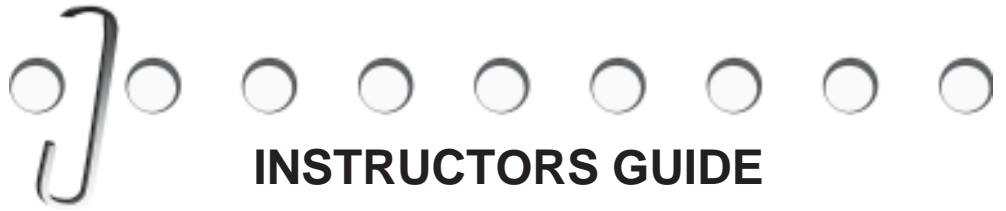
*Chapter 4 Para 6***ILS**

ILS employs a battery backup system in case of mains failure so that operations can continue. The equipment is self-monitoring and is able to indicate any fault to the user (in the approach control) via a remote status indicator (RSI).

The codes received by the pilot as each marker is passed are:

Outer	400 Hz keying at 2 dashes per second.
Middle	1300 Hz consisting of alternate dots and dashes.
Inner	3000 Hz keying at 6 dots per second or a station code.

*Chapter 4 Para 17***TACAN**

In the absence of interrogation signals, random receiver noise (squitter) is used to simulate interrogation signals, hence maintaining the beacon's duty cycle. The beacon is also responsible for selfmonitoring.

TACAN is also available as a mobile version for emergency cover/use. This version has a range of 100 miles (half that of a fixed version).



INSTRUCTORS GUIDE

SELF ASSESSMENT QUESTIONS - ANSWER SHEET

Chapter 1 Page 35.3.1-10

1a

2a

3c

4a

Chapter 2 Page 35.3.2-4

1a

2c

3c

Chapter 3 Page 35.3.3-12

1c

2d

3a

4b

5a

Chapter 4 Page 35.3.4-14

1a

2b

3c

4d

5a